

# SACC-M12MR-5CON-PG9-M - Connector



1681473

<https://www.phoenixcontact.com/it/products/1681473>

Please be informed that the data shown in this PDF document is generated from our online catalog. Please find the complete data in the user documentation. Our general terms of use for downloads are valid.

Connector, Universal, 5-position, Plug angled M12, coding: A, Screw connection, knurl material: Zinc die-cast, nickel-plated, cable gland Pg9, external cable diameter 6 mm ... 8 mm



## Your advantages

- Safe use in the field, thanks to a high degree of protection
- Screw connection: proven connection technology for a large selection of different conductors

## Commercial data

Item number	1681473
Packing unit	1 pc
Minimum order quantity	1 pc
Sales key	AF2
Product key	AF2CAA
Catalog page	Page 22 (C-2-2019)
GTIN	4017918157470
Weight per piece (including packing)	26.18 g
Weight per piece (excluding packing)	24.6 g
Customs tariff number	85366990
Country of origin	DE

## Technical data

### Notes

Assembly note	<b>NOTE:</b> Observe the permissible bending radii when routing cables, since the degree of protection may be at risk if the bending forces are too high. Reduce mechanical loads upstream of the connector, e.g., by using cable ties.
---------------	---

### Mounting

Assembly note	The connector pin assignment can be rotated 90° to the cable outlet
---------------	---

### Product properties

Product type	Circular connector (cable-side)
Sensor type	Universal
Number of positions	5
No. of cable outlets	1
Shielded	no
Coding	A
Cable outlet	angled
Pg screw connection	Pg9

### Insulation characteristics

Overvoltage category	II
Degree of pollution	3

### Dimensions

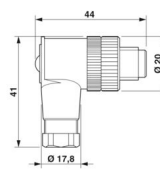
Dimensional drawing	
Length	41 mm

### External dimensions

Outside diameter	6 mm ... 8 mm
------------------	---------------

### Housing

Diameter housing	20 mm
------------------	-------

### Material specifications

Flammability rating according to UL 94	HB
Seal material	NBR
Material of grip body	PA
Contact material	CuZn

# SACC-M12MR-5CON-PG9-M - Connector



1681473

<https://www.phoenixcontact.com/it/products/1681473>

Contact surface material	CuSnZn
Contact carrier material	PA
Material for screw connection	Zinc die-cast, nickel-plated

## Connection data

### Conductor connection

Connection method	Screw connection
Connection cross section	0.25 mm <sup>2</sup> ... 0.75 mm <sup>2</sup> (without ferrule)
	0.14 mm <sup>2</sup> ... 0.75 mm <sup>2</sup> (with ferrule)
	0.25 mm <sup>2</sup> ... 0.75 mm <sup>2</sup> (solid)
Connection cross section AWG	24 ... 18 (without ferrule)
	26 ... 20 (with ferrule)
Stripping length of the individual wire	5 mm
Tightening torque	0.4 Nm (M12 knurl)
	0.2 Nm (Screw terminal blocks)
	0.8 Nm ... 1 Nm (Pressure screw with sleeve housing)

## Electrical properties

Rated surge voltage	1.5 kV
Contact resistance	≤ 8 mΩ
Insulation resistance	≥ 100 MΩ
Nominal voltage U <sub>N</sub>	48 V AC
	60 V DC
Nominal current I <sub>N</sub>	4 A

## Mechanical properties

### Mechanical data

Insertion/withdrawal cycles	≥ 50
-----------------------------	------

## Connector

### Connection 1

Head design	Plug
Head cable outlet	angled
Head thread type	M12
Coding	A

## Cable/line

Signal type/category	Universal
Stripping length of the individual wire	5 mm

## Environmental and real-life conditions

### Ambient conditions

Degree of protection	IP67
----------------------	------

# SACC-M12MR-5CON-PG9-M - Connector



1681473

<https://www.phoenixcontact.com/it/products/1681473>

Ambient temperature (operation) (male connector/female connector)
---

-40 °C ... 85 °C (Plug / socket)
----------------------------------

## Standards and regulations

Standard designation
----------------------

M12 connector
---------------

Standards/specifications
--------------------------

IEC 61076-2-101
-----------------

# SACC-M12MR-5CON-PG9-M - Connector

1681473

<https://www.phoenixcontact.com/it/products/1681473>

## Drawings

Dimensional drawing

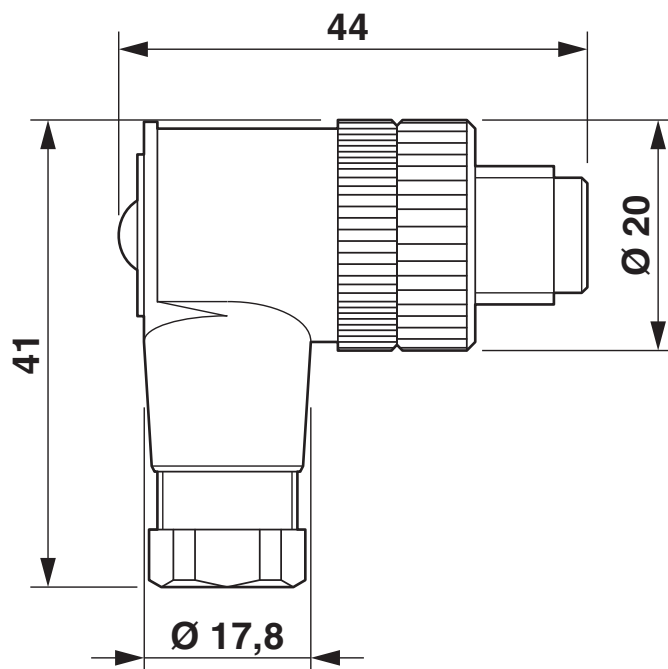

M12 x 1 male plug, angled

Schematic diagram

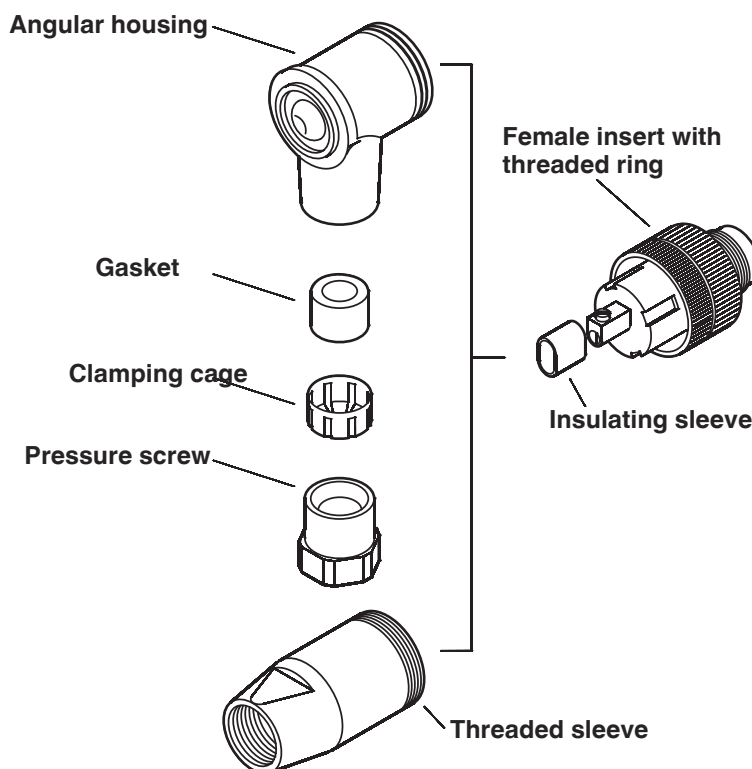

Male/Female M12

Schematic diagram

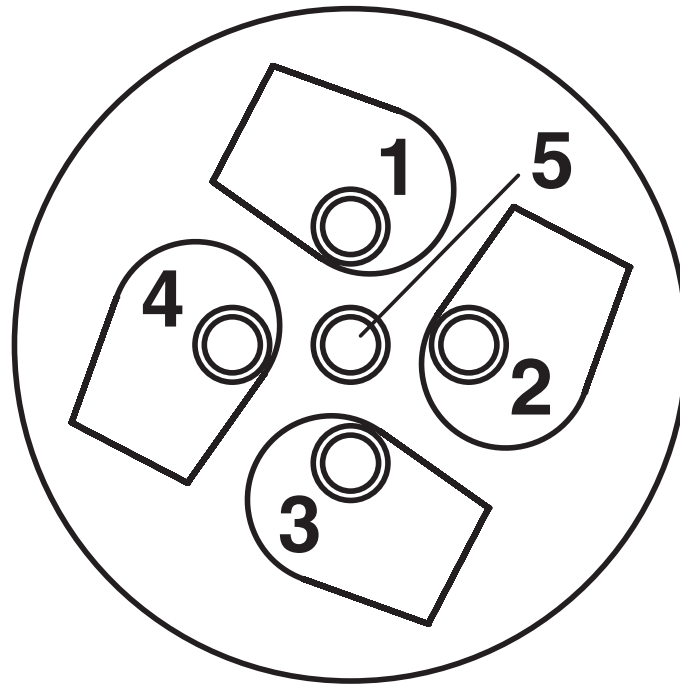

Cable connection side M12 (screw connection)

Schematic diagram

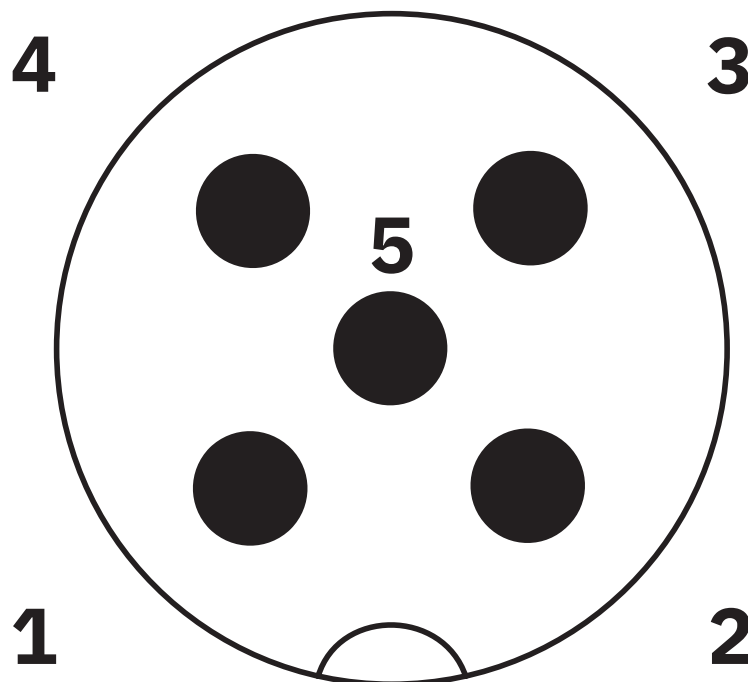

Pin assignment M12 male connector, 5-pos., A-coded, male side

# SACC-M12MR-5CON-PG9-M - Connector





1681473

<https://www.phoenixcontact.com/it/products/1681473>

## Approvals

To download certificates, visit the product detail page: <https://www.phoenixcontact.com/it/products/1681473>

 <b>cUL Recognized</b> Approval ID: FILE E 221474				
	Nominal voltage $U_N$	Nominal current $I_N$	Cross section AWG	Cross section $mm^2$
	60 V	4 A	-	-

 <b>UL Recognized</b> Approval ID: FILE E 221474				
	Nominal voltage $U_N$	Nominal current $I_N$	Cross section AWG	Cross section $mm^2$
	60 V	4 A	-	-

# SACC-M12MR-5CON-PG9-M - Connector



1681473

<https://www.phoenixcontact.com/it/products/1681473>

## Classifications

### ECLASS

ECLASS-13.0

27440116

### ETIM

ETIM 9.0

EC002635

### UNSPSC

UNSPSC 21.0

39121400



1681473

<https://www.phoenixcontact.com/lt/products/1681473>

## Environmental product compliance

### EU RoHS

Fulfills EU RoHS substance requirements	Yes
Exemption	6(c)

### China RoHS

Environment friendly use period (EFUP)	EFUP-50
	An article-related China RoHS declaration table can be found in the download area for the respective article under "Manufacturer declaration". For all articles with EFUP-E, no China RoHS declaration table issued and required.

### EU REACH SVHC

REACH candidate substance (CAS No.)	Lead(CAS: 7439-92-1)
SCIP	0bded778-efbf-4e34-b9bd-1fc98272d29c

Phoenix Contact 2025 © - all rights reserved

<https://www.phoenixcontact.com>

Phoenix Contact UAB

Svitrigailos str. 11B

03228 Vilnius

+370 5 2106321

[balticinfo@phoenixcontact.com](mailto:balticinfo@phoenixcontact.com)